







MADISON Bath shower set for bath rim or tile edge installation - Brushed Durabronz (23kt Gold)

MADISON

ST 030 100 3370



- spout: circular, air-enriched flow
- max. spout flow rate 23 l/min
- Hand shower: COMPACT RAIN, max. flow rate 6.8 l/min (at 3 bar)
- complete hand shower set with anti-scale system
- 225mm projection
- automatic bath/shower diverter
- height of mixer 185 mm
- height up to aerator 140 mm
- hole diameter valve 32 mm
- hole diameter spout 32 mm
- hole diameter for complete hand shower set 32 mm
- rosette for spout Ø 70mm
- rosette for complete hand shower set Ø 60mm
- rosette for deck valve Ø 60mm
- metal shower hose 1750mm with integrated anti-twist protection

	Brushed Durabronz (23kt Gold)	ST 030 100 3370-28
	Chrome	ST 030 100 3370-00
	Brushed Platinum	ST 030 100 3370-06
	Platinum	ST 030 100 3370-08
	Durabronz (23kt Gold)	ST 030 100 3370-09
	Brushed Dark Platinum	ST 030 100 3370-99

Individual components of this set

You need the following components for this set

2x 11 170 370-28



1x 27 502 370-28





MADISON Bath shower set for bath rim or tile edge installation - Brushed
Durabronz (23kt Gold)

MADISON

ST 030 100 3370

MADISON Bath shower set for bath rim or tile edge installation - Brushed Durabron (23kt Gold)



MADISON

ST 030 100 3370

- for basin fittings

NOTE: Mixers are supplied without lever inserts.
Please order the lever inserts separately!



	Brushed Durabron (23kt Gold)	11 170 370-28
	Chrome	11 170 370-00
	Brushed Platinum	11 170 370-06
	Platinum	11 170 370-08
	Durabron (23kt Gold)	11 170 370-09
	white	11 170 370-12
	black	11 170 370-13
	Brushed Dark Platinum	11 170 370-99

ST 030 100 3370





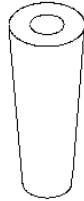



ST 030 100 3370
Parts for other finishes can be found here: [Chrome](#)



- 225mm projection
- complete hand shower set: normal flow
- spout: circular, air-enriched flow
- complete hand shower set with anti-scale system
- automatic bath/shower diverter
- height of mixer 185 mm
- height up to aerator 140 mm
- hole diameter valve 32 mm
- hole diameter spout 32 mm
- hole diameter for complete hand shower set 32 mm
- rosette for spout Ø 70mm
- rosette for complete hand shower set Ø 60mm
- rosette for deck valve Ø 60mm
- metal shower hose 1750mm with integrated anti-twist protection
- max. spout flow rate 23 l/min
- max. flow for complete hand shower set 6.8 l/min

Intrinsic protection against back flow.

Note: Local building codes may require the use of an anti-scald device. Please refer to remote pressure balance valve (35 910 970 90)

	Brushed Durabron (23kt Gold)	27 502 370-28
	Chrome	27 502 370-00
	Brushed Platinum	27 502 370-06
	Platinum	27 502 370-08
	Durabron (23kt Gold)	27 502 370-09
	Brushed Dark Platinum	27 502 370-99



MADISON Bath shower set for bath rim or tile edge installation - Brushed
Durabrass (23kt Gold)

MADISON

ST 030 100 3370



MADISON Bath shower set for bath rim or tile edge installation - Brushed
Durabronz (23kt Gold)

MADISON

ST 030 100 3370



MADISON Bath shower set for bath rim or tile edge installation - Brushed
Durabronz (23kt Gold)

MADISON

ST 030 100 3370

ST 030 100 3370
mm [inches]
1:10

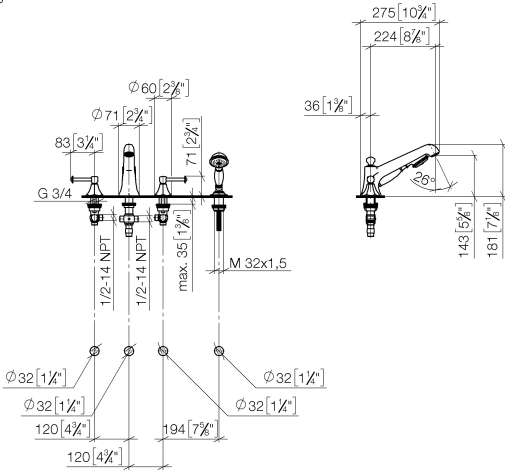

Flow rate chart

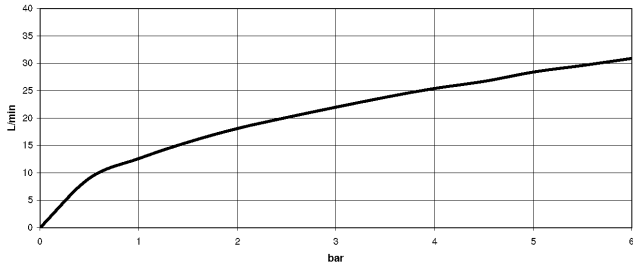

Certificates

LGA_8028.

Belgaqua_21-380-
27_4.

ST 030 100 3370
Parts for other
finishes can be found
here: Chrome

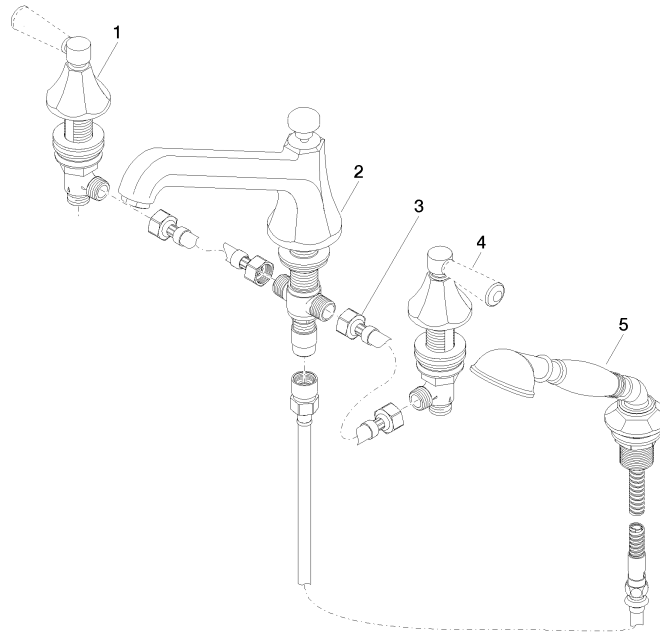

Spare parts list

No.	Item Number	Name	Quantity used	Delivery time
1	20 000 370-28	side panel	1	60
2	13 502 380-28	spout	1	-
Spare part can no longer be ordered, please order the replacement item				
3	12 502 970 90	High pressure hose 1/2" x 1/2" x 400 mm -	2	2
4	20 000 371-28	side panel	1	60
5	27 703 370-28	shower set	1	-
Spare part can no longer be ordered, please order the replacement item				